

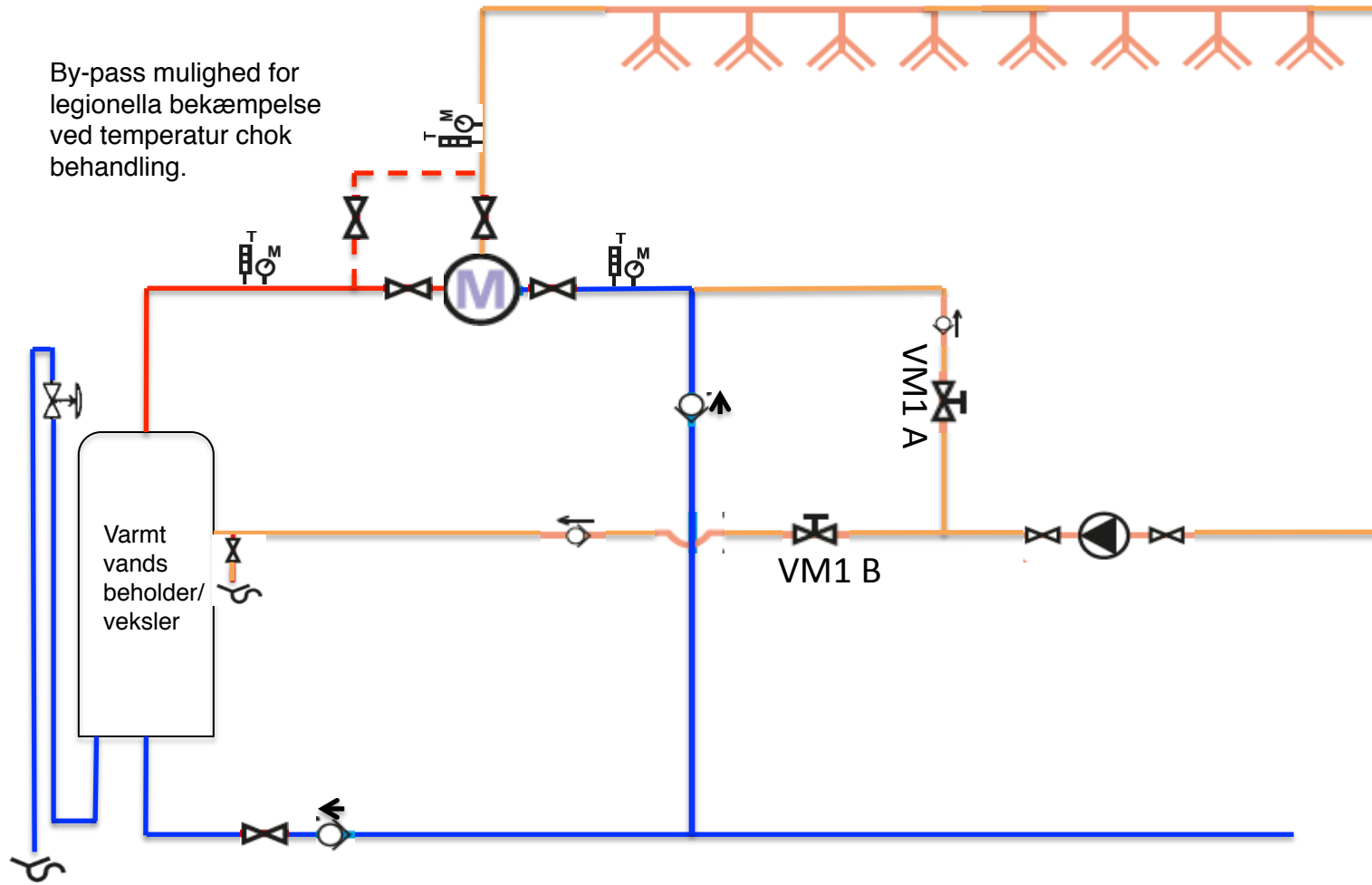







# Cirkulationsdiagram med BY-PASS.



By-pass mulighed for legionella bekæmpelse ved temperatur chok behandling.



- |  |  |  |  |
|--|--|--|--|
|  Afspærrings ventil   |  Sikkerhedsventil 6 bar |  Termometer |  Blandeventil CMA Eurotherm |
|  Strengregulerings ventil<br>VM 1 A – indstilling 75 – 80 % åben<br>VM 1 B – indstilling 15 – 20 % åben |  Kontraventil           |  Manometer  |  Cirkulations pumpe         |